

A(2:15)

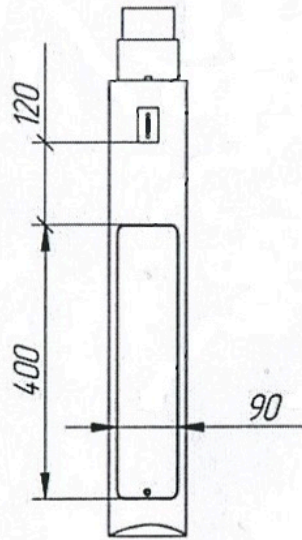

B-B(1:4)

